



Maxim™ Series LFM300, LFM300N

Double Check Detector Assemblies

Sizes: 2½" – 10"

LEAD FREE*



LFM300 BFG



LFM300 OSY

Features

- Extremely Compact Design
- 70% Lighter than Traditional Designs
- 304 (Schedule 40) Stainless Steel Housing & Sleeve
- Groove Fittings Allow Integral Pipeline Adjustment
- Patented Tri-Link Check Provides Lowest Pressure Loss
- Unmatched Ease of Serviceability
- Available with Grooved Butterfly Valve Shutoffs
- Available for Horizontal, Vertical or N Pattern Installations
- Replaceable Check Disc Rubber

The Maxim LFM300, LFM300N Double Check Detector Assemblies are used to prevent backflow of pollutants, that are objectionable but not toxic, from entering the potable water supply system. The Maxim LFM300, LFM300N may be installed under continuous pressure service and may be subjected to backpressure. The Maxim LFM300, LFM300N are used primarily on fire line sprinkler systems when it is necessary to monitor unauthorized use of water. For use in non-health hazard applications. The LFM300/LFM300N features Lead Free* construction to comply with Lead Free* installation requirements.

Specifications

The Lead Free* Double Check Detector Assemblies shall consist of two independent Tri-Link Check modules within a single housing, sleeve access port, four test cocks and two drip tight shutoff valves. Tri-Link Checks shall be removable and serviceable, without the use of special tools. The housing shall be constructed of 304 (Schedule 40) stainless steel pipe with groove end connections. Double Check Valve Assemblies shall comply with state codes and standards, where applicable, requiring reduced lead content. Tri-Link Checks shall have reversible elastomer discs and in operation shall produce drip tight closure against the reverse flow of liquid caused by backpressure or backsiphonage. The bypass assembly consists of a meter registering either gallon or cubic feet measurements, a double check valve assembly and required test cocks. Assembly shall be a Maxim LFM300, LFM300N as manufactured by the Ames Company.

NOTICE

The information contained herein is not intended to replace the full product installation and safety information available or the experience of a trained product installer. You are required to thoroughly read all installation instructions and product safety information before beginning the installation of this product.

*The wetted surface of this product contacted by consumable water contains less than 0.25% of lead by weight.

Job Name _____ Contractor _____

Job Location _____ Approval _____

Engineer _____ Contractor's P.O. No. _____

Approval _____ Representative _____

Configurations

- Horizontal
- Vertical up
- “N” pattern horizontal

Materials

- Housing & Sleeve: 304 (Schedule 40) Stainless Steel
- Elastomers: EPDM, Silicone and Buna ‘N’
- Tri-Link Checks: Noryl®, Stainless Steel
- Check Discs: Reversible Silicone or EPDM
- Test Cocks: Bronze Body Nickel Plated
- Pins & Fasteners: 300 Series Stainless Steel
- Springs: Stainless Steel

Available Models

OSY - UL/FM flanged outside stem and yoke resilient seated gate valves

BFG - UL/FM grooved gear operated butterfly valves w/tamper switch

*OSY FxG - Flanged inlet gate connection and grooved outlet gate connection

*OSY GxF - Grooved inlet gate connection and flanged outlet gate connection

*OSY GxG - Grooved inlet gate connection and grooved outlet gate connection

Available with grooved NRS gate valves - consult factory*

Post indicator plate and operating nut available - consult factory*

*Consult factory for dimensions

Pressure — Temperature

Temperature Range: 33°F – 110°F (5°C – 43°C)

Maximum Working Pressure: 175psi (12.06 bar)

Dimensions — Weights

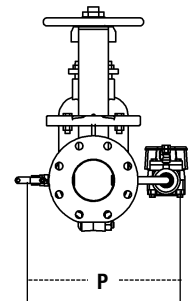
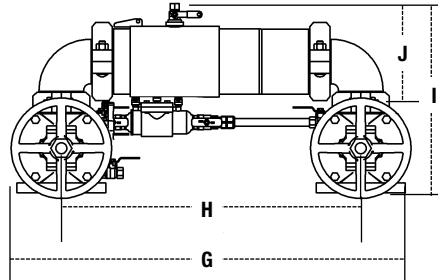
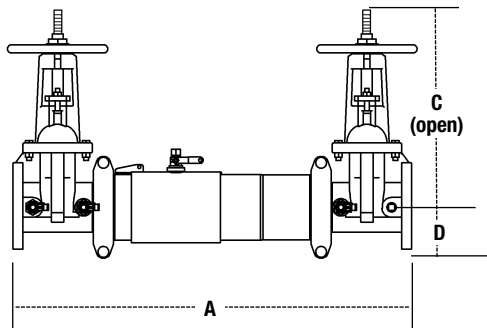

LFM300, LFM300N

SIZE	DIMENSIONS														WEIGHT					
	A		C (OSY)		D		G		H		I		J		P		M300		M300N	
in	in	mm	in	mm	in	mm	in	mm	in	mm	in	mm	in	mm	in	mm	lbs.	kgs.	lbs.	kgs.
2½	30¾	781	16⅜	416	3½	89	29⅞	738	21½	546	15⅞	402	8⅜	223	13⅜	335	139	63	147	67
3	31¾	806	18⅞	479	3⅞	94	30½	775	22¼	565	17⅞	435	9⅞	233	14½	368	159	72	172	78
4	40½	1029	22¾	578	5	127	39¾	1010	30¼	768	20⅞	518	11⅞	297	15⅞	386	233	106	256	116
6	47¾	1213	30⅞	765	6½	165	40	1016	37½	953	24¾	629	14⅞	360	19½	495	404	183	444	201
8	54¾	1391	37¾	959	7½	191	59⅞	1502	45⅞	1146	28⅞	721	16¾	425	21½	546	578	262	654	297
10	57¾	1467	45¾	1162	8⅞	208	66	1676	49½	1257	32½	826	17⅞	440	24	610	795	361	965	438

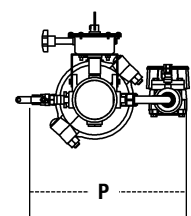
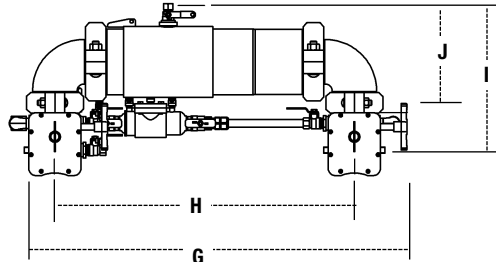
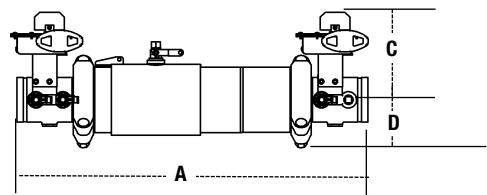

LFM300BFG, LFM300NBFG

SIZE	DIMENSIONS														WEIGHT					
	A		C		D		G		H		I		J		P		M300BFG		M300NBFG	
in.	in.	mm	in.	mm	in.	mm	in.	mm	in.	mm	in.	mm	in.	mm	in.	mm	lbs.	kgs.	lbs.	kgs.
2½	27¾	705	8	203	3½	89	29⅞	759	21½	546	14⅞	379	8⅜	223	13	330	70	32	78	35
3	28¼	718	8⅞	211	3⅞	94	30¾	781	22¼	565	15⅞	392	9⅞	233	13½	343	68	31	81	37
4	35¾	908	8⅞	221	4⅞	122	39	991	30¼	768	18	457	11⅞	297	15	381	133	60	156	71
6	40¾	1035	10	254	6	152	47⅞	1205	37½	953	20⅞	525	14⅞	360	19½	495	225	102	265	120
8	47¾	1213	12⅞	310	6⅞	173	56	1422	45⅞	1146	24⅞	613	16¾	425	21½	546	359	163	435	197

Approvals



For additional approval information please contact the factory or visit our website at www.amesfirewater.com

Flow capacity chart identifies valve performance based upon rated water velocity up to 25fps

- Service Flow is typically determined by a rated velocity of 7.5fps based upon schedule 40 pipe.
- Rated Flow identifies maximum continuous duty performance determined by AWWA.
- UL Flow Rate is 150% of Rated Flow and is not recommended for continuous duty.
- AWWA Manual M22 [Appendix C] recommends that the maximum water velocity in services be not more than 10fps.

Capacity

UL/FM Certified Flow Characteristics

Flow characteristics collected using butterfly shutoff valves.

— Horizontal — Vertical - - - - N-Pattern

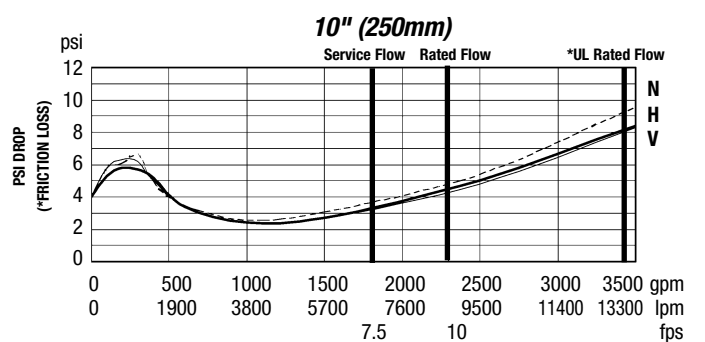
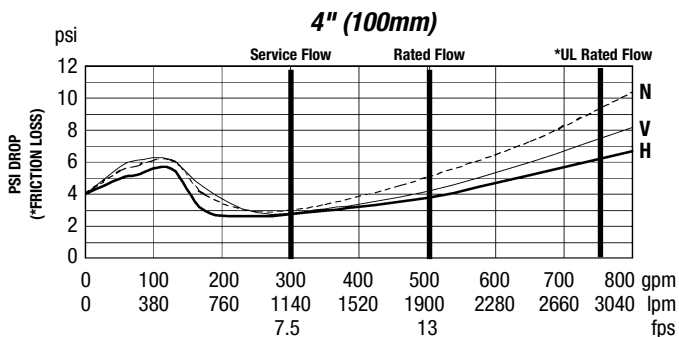
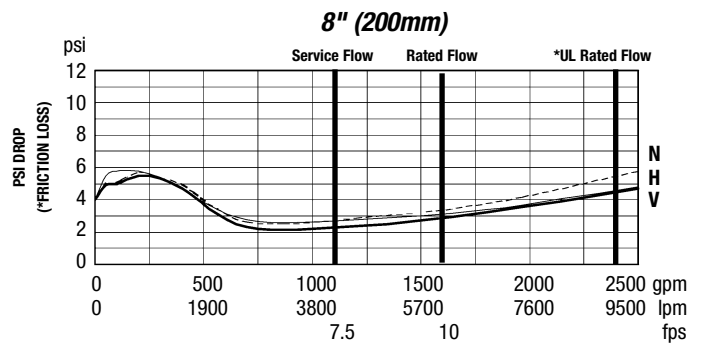
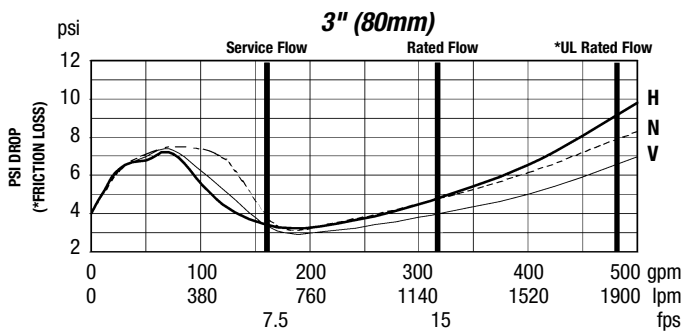
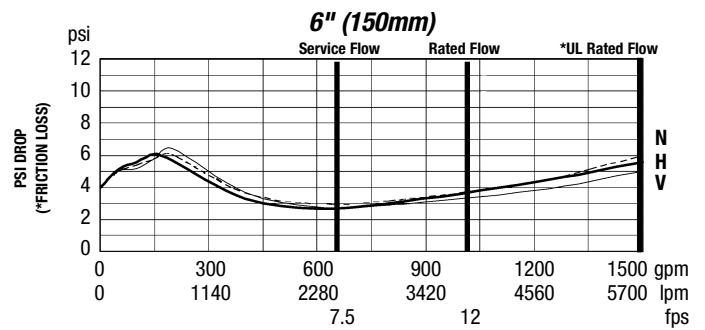
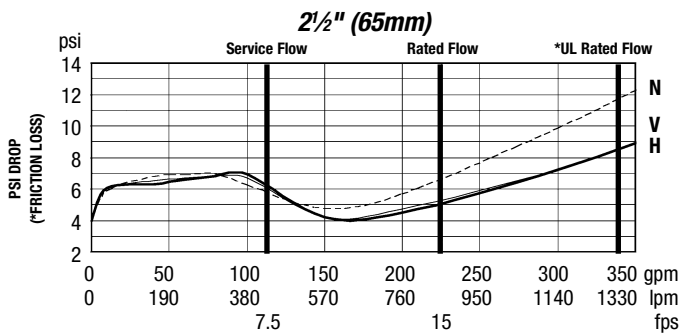

NOTICE

Inquire with governing authorities for local installation requirements



A Watts Water Technologies Company

USA: Backflow Tel: (978) 689-6066 • Fax: (978) 975-8350 • AmesFireWater.com
USA: Control Valves Tel: (713) 943-0688 • Fax: (713) 944-9445 • AmesFireWater.com
Canada: Tel: (905) 332-4090 • Fax: (905) 332-7068 • AmesFireWater.ca
Latin America: Tel: (52) 81-1001-8600 • Fax: (52) 81-8000-7091 • AmesFireWater.com