

Job Name _____
 Job Location _____
 Engineer _____
 Approval _____

Contractor _____
 Approval _____
 Contractor P.O. No. _____
 Representative _____

Series 008QT

High Hazard Backflow Preventer

Anti-Siphon, Spill-Resistant

Designed for indoor point of use applications to prevent back-siphonage of contaminated water back into the potable water supply. Separation of the water supply from the air inlet is accomplished by means of a diaphragm seal. This feature protects against any spillage during start-up or operation.

SIZES

3/8", 1/2", 3/4" and 1" (10, 15, 20, 25mm)

FEATURES

- Standardly supplied with Tee handles
- Available less Tee handle with stem wrench flats. For use where space is limited
- Available in left-handed or right-handed outlet
- Patented design
- Spill-resistant design for indoor use
- Affordable design
- Modular cartridge for ease of service
- Vent uses an o-ring for reliable operation
- Bronze body for durability
- Compact space saving design
- ASSE 1056
- IAPMO Classified

INSTALLATION

The SVB is designed to be installed at the point of use. When factory installed deck/machine mounted on machines or equipment, the critical level of the SVB shall be not less than 1" (25mm) above the flood rim. If field applied for general plumbing applications, the critical level of the SVB shall be a minimum of 6" above the flood rim.

SPECIFICATIONS

A spill-resistant vacuum breaker (SVB) shall be installed, in accordance with the manufacturer's instructions, as noted on the plans. The valve shall consist of a one piece modular check and float assembly made of engineered thermoplastic and housed in a bronze body. Springs shall be stainless steel. The valve shall be constructed with a molded diaphragm separating the air inlet from the potable water supply to prevent spillage. The valve shall be a Watts SVB Series 008QT.

Watts product specifications in U.S. customary units and metric are approximate and are provided for reference only. For precise measurements, please contact Watts Technical Service. Watts reserves the right to change or modify product design, construction, specifications, or materials without prior notice and without incurring any obligation to make such changes and modifications on Watts products previously or subsequently sold.

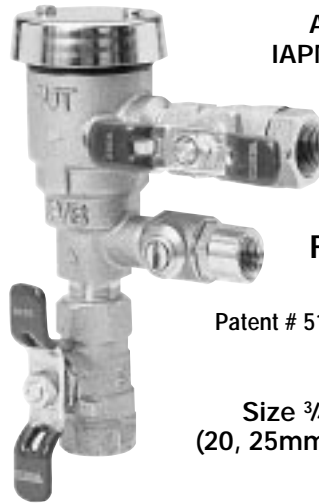

ASSE 1056
IAPMO Classified

FOR INDOOR USE!

Patent # 5125429

Size 3/4", 1"
(20, 25mm) shown

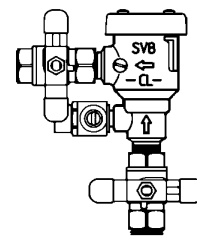
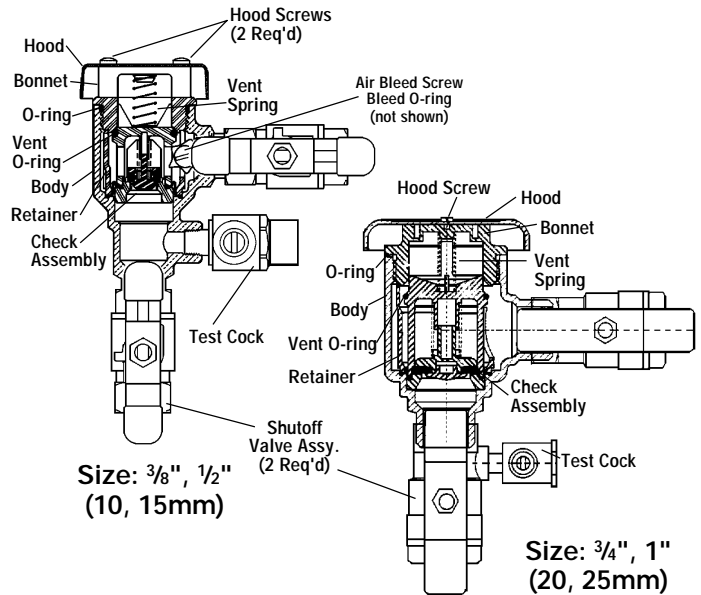

008QT-L (Left-Handed)

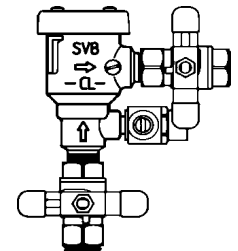

008QT (Right-Handed)



MATERIALS

- Springs - Stainless Steel
- Bonnet - PPO
- Vent Disc - EPDM
- Disc Holder - PPO
- Check Disc - Silicone Rubber
- Body - Bronze

DIMENSIONS - WEIGHT

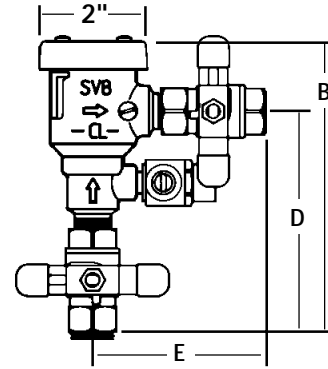

PRESSURE - TEMPERATURE

Working Temp: 33° - 180°F (1° - 83°C)
 Max Pressure: 150 psi (10.34 bars) - Min Pressure: 8 psi (55.2 kPa)

END CONNECTIONS

Female NPT - Ball Valve shut-offs.
 Hose and Custom Connections

TYPICAL INSTALLATION

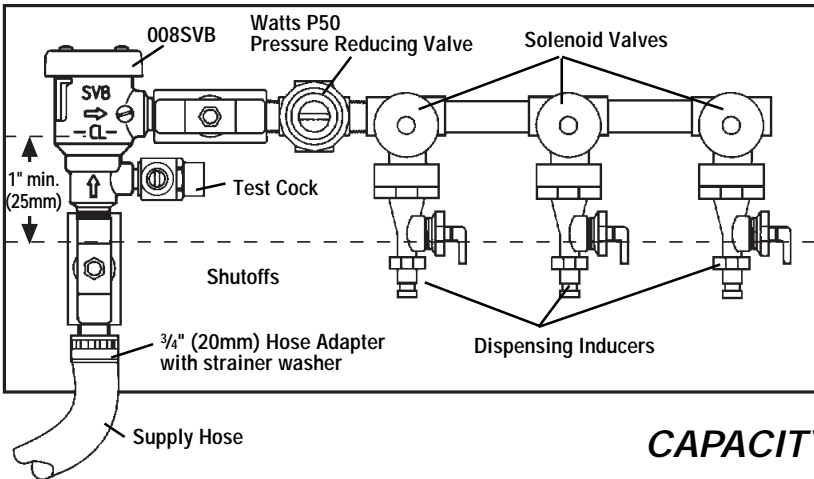

Size DN	Dimensions (approx.)						Weight			
	in.	mm	B in.	B mm	D in.	D mm	E in.	E mm	lbs.	kgs.
3/8	10	25.4	5 1/2	140	4	102	3 3/8	79	1.6	.73
1/2	15	38.1	5 3/4	146	4 1/4	108	3 3/8	86	1.7	.77
3/4	20	50.8	7	178	4 5/8	117	4 1/2	114	3.8	1.72
1	25	63.5	7 1/2	191	5	127	4 7/8	124	4.8	2.18

CAPACITY

As compiled from documented Foundation for Cross-Connection Control and Hydraulic Research at the University of Southern California lab tests.

*Typical maximum system flow rate (7.5 feet/sec.)

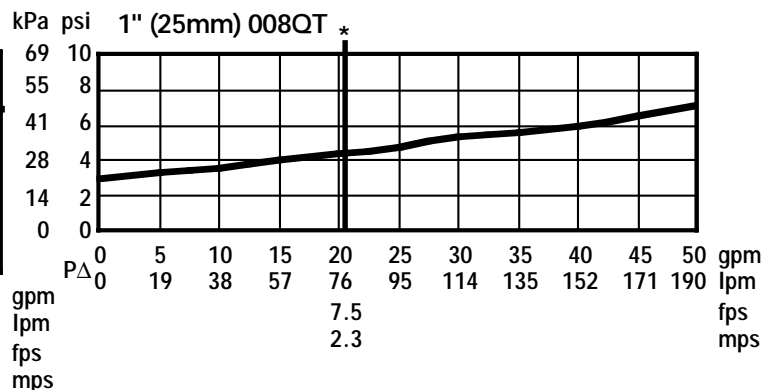
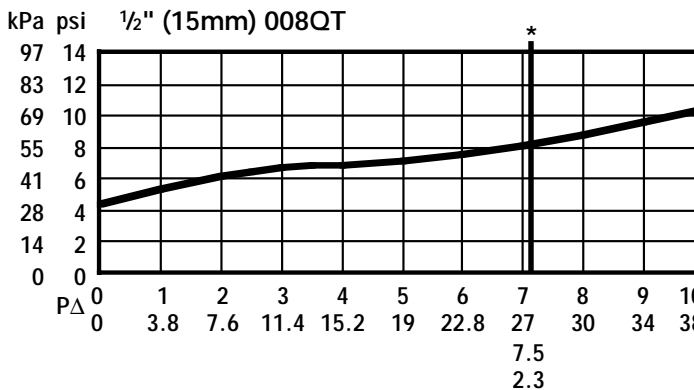
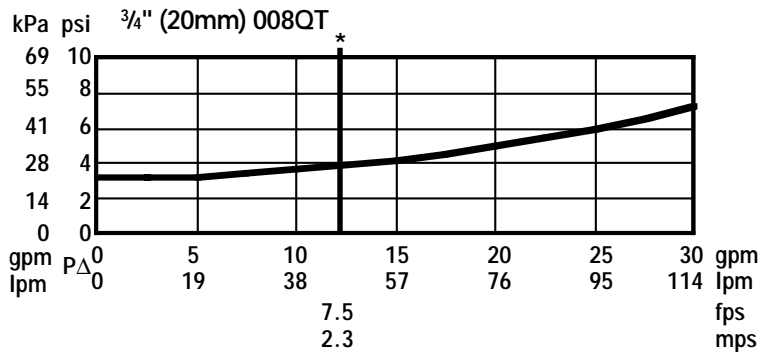
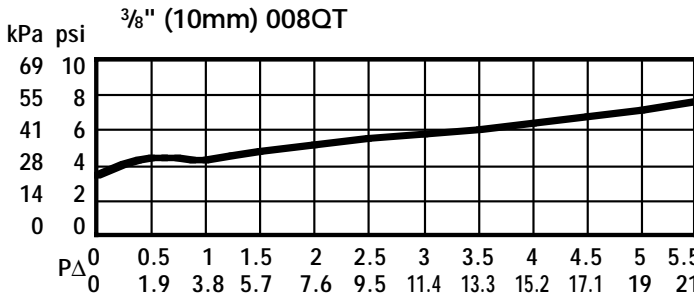

USA: 815 Chestnut Street, North Andover, MA 01845-6098
 Canada: 5435 North Service Road, Burlington, Ontario L7L 5H7
 www.wattsind.com

