

For Health Hazard Applications

Job Name _____

Contractor _____

Job Location _____

Approval _____

Engineer _____

Contractor's P.O. No. _____

Approval _____

Representative _____

LEAD FREE*

Series 957, 957N, 957Z

Reduced Pressure Zone Assemblies

Sizes: 2½" – 10" (65 – 250 mm)

Series 957, 957N, 957Z Reduced Pressure Zone Assemblies provide protection to the potable water system from contamination in accordance with national plumbing codes. Series 957, 957N, 957Z are normally used in health hazard applications for protection against backsiphonage or backpressure.

Features

- 2½", 3" and 4" (65, 80 and 100mm) sizes available with quarter-turn ball valve shutoffs
- Replaceable check disc rubber
- Extremely compact design
- 70% Lighter than traditional designs
- 304 (Schedule 40) stainless steel housing & sleeve
- Groove fittings allow integral pipeline adjustment
- Patented torsion spring checks provide lowest pressure loss
- Unmatched ease of serviceability
- Bottom mounted cast stainless steel relief valve
- Available with grooved butterfly valve shutoffs

Specifications

The Reduced Pressure Zone Assembly shall consist of two independent torsion spring check modules, a differential pressure relief valve located between and below the two modules, two drip tight shutoff valves, and required torsion spring check modules and relief valve shall be contained with a sleeve accessible single housing constructed from 304 (Schedule 40) stainless steel pipe with groove end connections. Torsion spring checks shall have replaceable elastomer discs and in operation produce drip tight closure against the reverse flow of liquid caused by backpressure or backsiphonage. Assembly shall be a Watts Regulator Company Series 957, 957N, 957Z.

NOTICE

Inquire with governing authorities for local installation requirements

*The wetted surface of this product contacted by consumable water contains less than 0.25% of lead by weight.

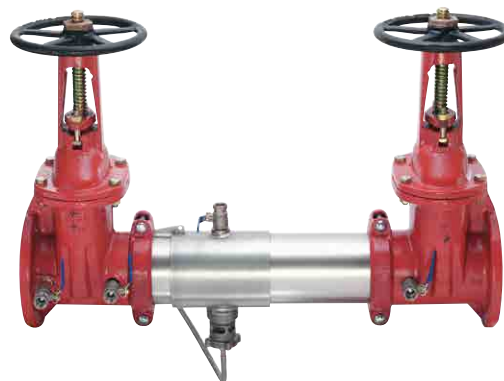

957OSY

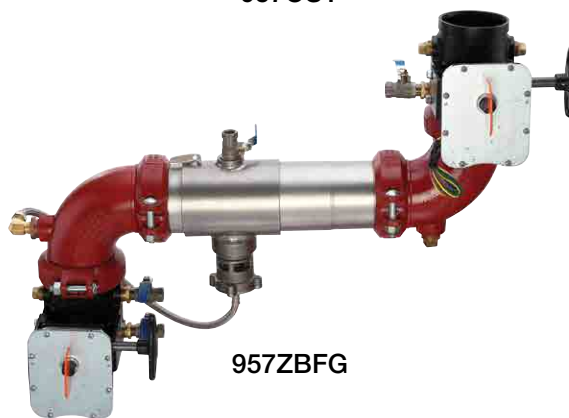

957ZBFG



957QT

NOTICE

The information contained herein is not intended to replace the full product installation and safety information available or the experience of a trained product installer. You are required to thoroughly read all installation instructions and product safety information before beginning the installation of this product.

Watts product specifications in U.S. customary units and metric are approximate and are provided for reference only. For precise measurements, please contact Watts Technical Service. Watts reserves the right to change or modify product design, construction, specifications, or materials without prior notice and without incurring any obligation to make such changes and modifications on Watts products previously or subsequently sold.

Available Models

Suffix:

- NRS – non-rising stem, resilient seated gate valves
- OSY – UL/FM outside stem and yoke resilient seated gate valves
- BFG – UL/FM grooved gear operated butterfly valves with tamper switch
- QT – 2½" - 4" (65 - 100mm) quarter-turn ball valves
- **OSY FxG – Flanged inlet gate connection and grooved outlet gate connection
- **OSY GxF – Grooved inlet gate connection and flanged outlet gate connection
- **OSY GxG – Grooved inlet gate connection and grooved outlet gate connection

Available with grooved NRS gate valves - consult factory**

Post indicator plate and operating nut available - consult factory**

**Consult factory for dimensions

Note: When installing a drain line on Series 957 backflow preventers, use 957AG air gaps. See ES-AG/EL/TC for additional information.

Dimensions – Weight

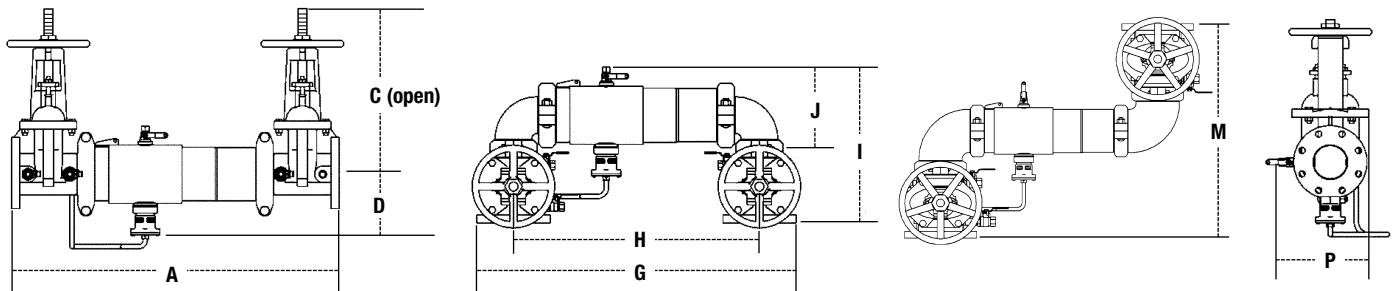

957, 957N, 957Z

SIZE (DN)		DIMENSIONS														WEIGHT													
in.	mm	A		C (OSY)		C (NRS)		D		G		H		I		J		M		P		957NRS		957OSY		957N NRS		957N OSY	
		in.	mm	in.	mm	in.	mm	in.	mm	in.	mm	in.	mm	in.	mm	in.	mm	in.	mm	in.	mm	lbs.	kgs.	lbs.	kgs.	lbs.	kgs.	lbs.	kgs.
2½	65	30¾	781	16⅞	416	9⅞	238	6½	165	29⅛	738	21½	546	15½	393	8⅜	223	21¼	540	9⅞	234	118	54	128	58	126	57	136	62
3	80	31¾	806	18⅞	479	10¼	260	6⅞	170	30¼	768	22¼	565	17⅞	435	9⅞	233	23	584	10½	267	134	61	148	67	147	67	161	73
4	100	33¾	857	22¾	578	12⅞	310	7	178	33	838	23½	597	18½	470	9⅞	252	26¼	667	11⅞	284	164	74	164	74	187	85	187	85
6	150	43½	1105	30⅞	765	16	406	8½	216	44¾	1137	35¼	895	23⅞	589	13⅞	332	34¼	870	15	381	276	125	298	135	317	144	339	154
8	200	49¾	1264	37¾	959	19⅞	506	9⅞	246	54⅞	1375	40⅞	1019	27⅞	697	15⅞	399	36⅞	937	17⅞	437	441	200	483	219	516	234	558	253
10	250	57¾	1467	45¾	1162	23⅞	605	11⅞	285	66	1676	49½	1257	32½	826	17⅞	440	44½	1124	20	508	723	328	783	355	893	405	950	431

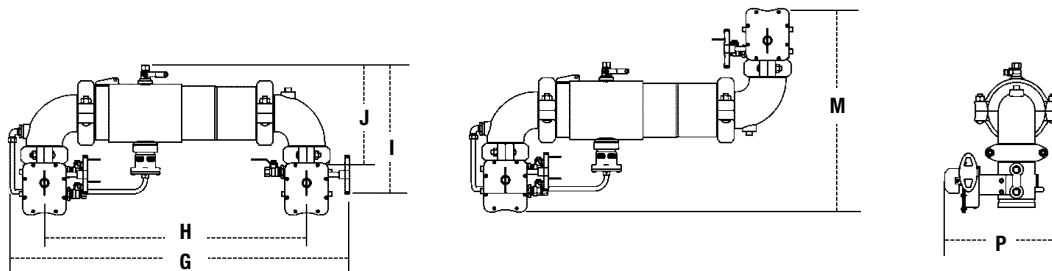

957NBFG, 957ZBFG

SIZE (DN)		DIMENSIONS										WEIGHT			
in.	mm	G		H		I		J		M		P		957N/957Z	
		in.	mm	in.	mm	in.	mm	in.	mm	in.	mm	in.	mm	lbs.	kgs.
2½	65	32½	826	23	584	15½	394	9½	241	19¾	502	11⅞	300	67	30
3	80	34	864	24	610	16⅞	414	10⅞	256	21¼	540	12⅞	308	70	32
4	100	35⅞	905	25½	648	17⅞	437	10⅞	279	23½	597	12⅞	321	87	39
6	150	46½	1181	35¼	895	20½	521	13½	343	27¼	692	15	382	160	73

Materials

Housing & Sleeve: 304 (Schedule 40) Stainless Steel

Elastomers: EPDM, Silicone and Buna-N

Torsion Spring Checks: Noryl®, Stainless Steel

Check Discs: Reversible Silicone or EPDM

Test Cocks: Bronze Body Nickel Plated

Pins & Fasteners: 300 Series Stainless Steel

Springs: Stainless Steel

Pressure – Temperature

Temperature Range: 33°F – 140°F (0.5°C – 60°C)

Maximum Working Pressure: 175psi (12.1 bar)

Approvals



(**BFG & OSY Only)

Dimensions — Weight continued

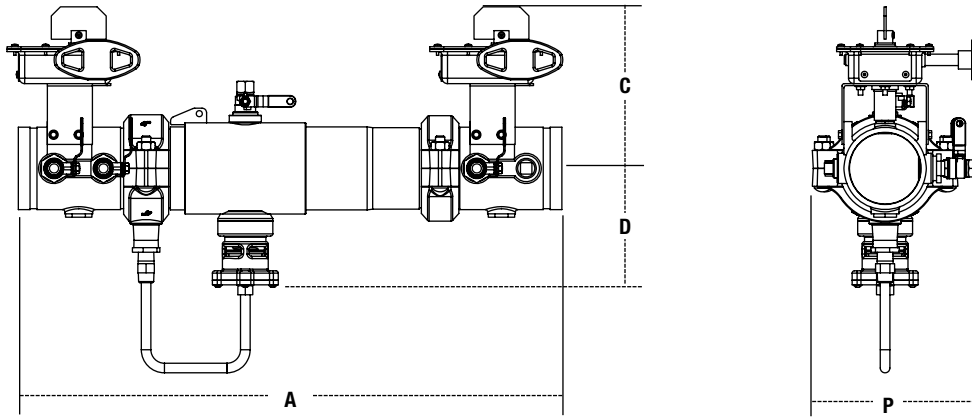

957 BFG

SIZE (DN)		DIMENSIONS								WEIGHT	
in.	mm	A		C		D		P		lbs.	kgs.
		in.	mm	in.	mm	in.	mm	in.	mm		
4	100	29	737	7 ³ / ₄	197	6 ³ / ₈	162	9 ¹ / ₂	241	66	30
6	150	36 ¹ / ₂	927	9 ¹¹ / ₁₆	246	7 ⁷ / ₁₆	189	14 ¹ / ₄	362	122	55

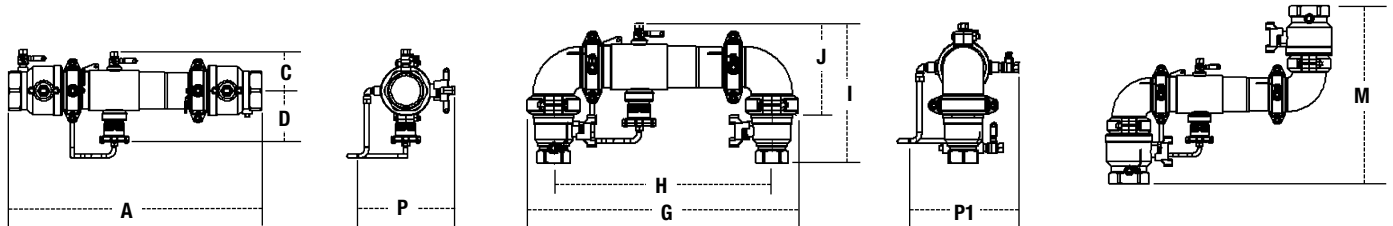

957QT

SIZE (DN)		DIMENSIONS										WEIGHT													
in.	mm	A		C		D		G		H		I		J		M		P		P1		QT		QTN	
		in.	mm	in.	mm	in.	mm	in.	mm	in.	mm	in.	mm	in.	mm	in.	mm	in.	mm	in.	mm	lbs.	kgs.	lbs.	kgs.
2 1/2	65	27 ¹ / ₂	698	4 ⁷ / ₈	124	6 ⁷ / ₈	175	30 ¹ / ₄	768	21 ¹ / ₂	546	16 1/16	407	11 ³ / ₈	289	19 ⁷ / ₈	505	11 ⁵ / ₁₆	287	11 ⁵ / ₁₆	287	46	21	57	26
3	80	28	711	4 ⁷ / ₈	124	6 ⁷ / ₈	175	30 ¹ / ₄	768	22 ¹ / ₄	565	16 ⁹ / ₁₆	420	11 ³ / ₈	289	20 ⁷ / ₈	531	11 ⁵ / ₁₆	287	11 ⁵ / ₁₆	287	56	25	67	30
4	100	28 ³ / ₄	730	4 ⁷ / ₈	124	6 ⁷ / ₈	175	30 ¹ / ₄	768	23 ¹ / ₂	597	18 ⁵ / ₁₆	465	11 ³ / ₈	289	24 ³ / ₈	619	11 ⁵ / ₁₆	287	11 ⁵ / ₁₆	287	76	34	87	39

Capacity

Series 957, 957N, 957Z flow curves as tested by Underwriters Laboratory.

Flow characteristics collected using butterfly shutoff valves

—— Horizontal ——— N-Pattern - - - - Z-Pattern

Flow capacity chart identifies valve performance based upon rated water velocity up to 25fps

- Service Flow is typically determined by a rated velocity of 7.5fps based upon schedule 40 pipe.
- Rated Flow identifies maximum continuous duty performance determined by AWWA.
- UL Flow Rate is 150% of Rated Flow and is not recommended for continuous duty.
- AWWA Manual M22 [Appendix C] recommends that the maximum water velocity in services be not more than 10fps.

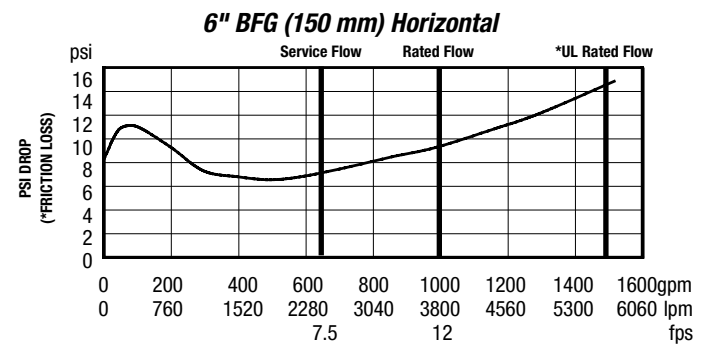
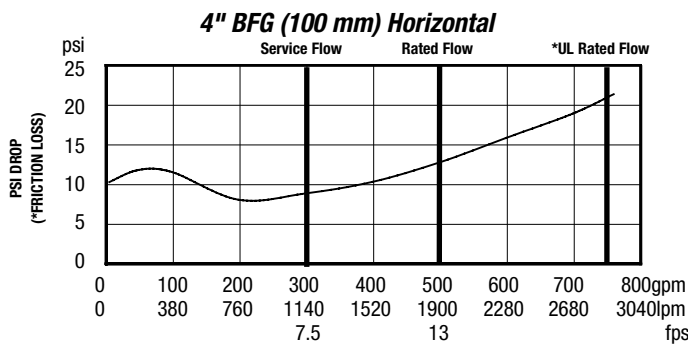
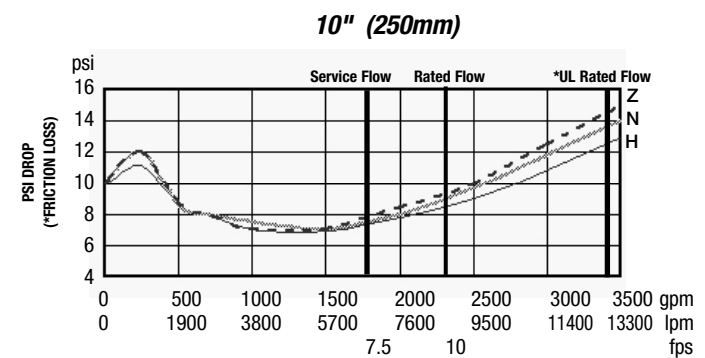
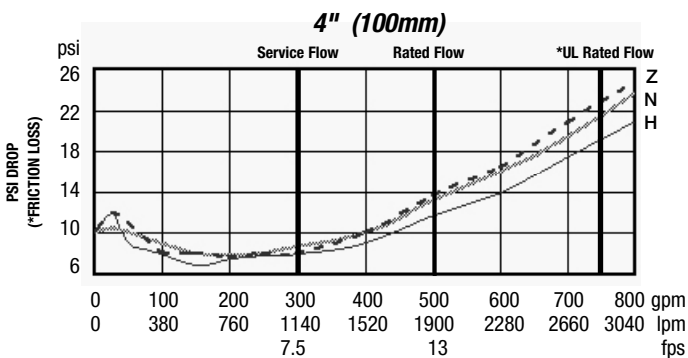
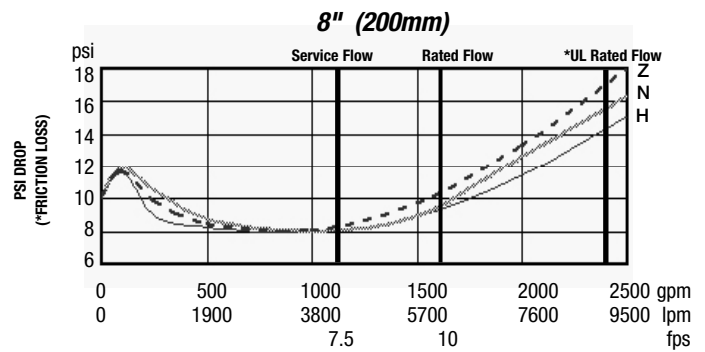
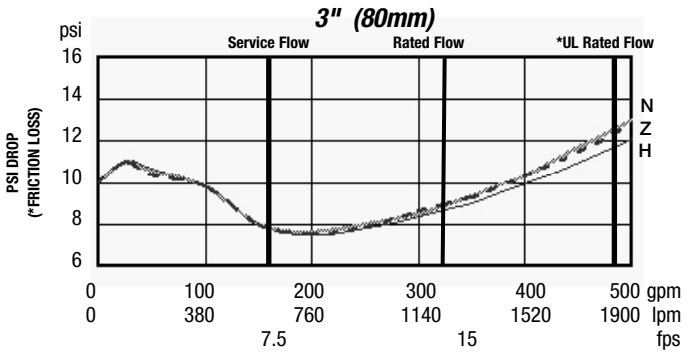
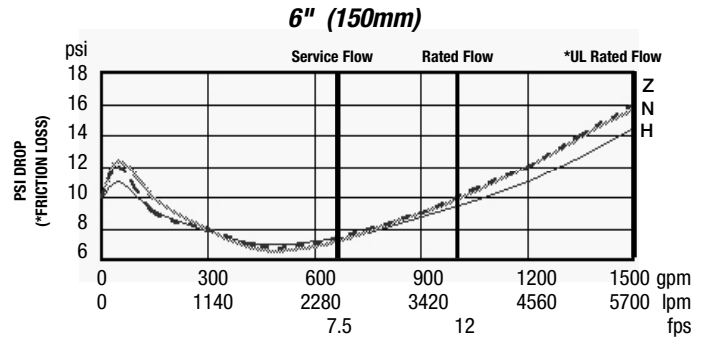
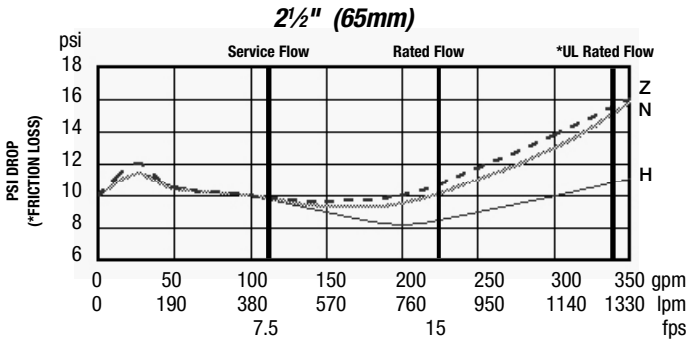

A Watts Water Technologies Company

USA: Tel: (978) 689-6066 • Fax: (978) 975-8350 • Watts.com

Canada: Tel: (905) 332-4090 • Fax: (905) 332-7068 • Watts.ca

Latin America: Tel: (52) 81-1001-8600 • Fax: (52) 81-8000-7091 • Watts.com