

## For Non-Health Hazard Applications

Job Name \_\_\_\_\_  
 Job Location \_\_\_\_\_  
 Engineer \_\_\_\_\_  
 Approval \_\_\_\_\_

Contractor \_\_\_\_\_  
 Approval \_\_\_\_\_  
 Contractor's P.O. No. \_\_\_\_\_  
 Representative \_\_\_\_\_

# LEAD FREE\*

## Series LF757DCDA, LF757NDCDA Double Check Detector Assemblies Sizes: 2½" – 10"

Series LF757DCDA, LF757NDCDA Double Check Detector Assemblies are used to prevent backflow of non-health hazard pollutants that are objectionable but not toxic, from entering the potable water supply system. The LF757DCDA, LF757NDCDA may be installed under continuous pressure service and may be subjected to backpressure and backsiphonage. Series LF757DCDA, LF757NDCDA is used primarily on fire line sprinkler systems when it is necessary to monitor unauthorized use of water.

### Features

- Lead Free\* construction
- Extremely compact design
- 70% lighter than traditional designs
- 304 (Schedule 40) stainless steel housing & sleeve
- Groove fittings allow integral pipeline adjustment
- Unique tri-link spring check provides lowest pressure loss
- Unmatched ease of serviceability
- Available with grooved butterfly valve shutoffs
- May be used for horizontal, vertical or N pattern installations
- Replaceable check disc rubber

### Specifications

The Lead Free\* Double Check Detector Assembly shall consist of two independent tri-link check modules within a single housing, sleeve access port, four test cocks and two drip tight shutoff valves. Tri-link checks shall be removable and serviceable, without the use of special tools. The housing shall be constructed of 304 Schedule 40 stainless steel pipe with groove end connections. Tri-link checks shall have reversible elastomer discs and in operation shall produce drip tight closure against reverse flow caused by backpressure or backsiphonage. The bypass assembly shall consist of a meter, which registers in either gallon or cubic measurement, a double check backflow assembly and required test cocks. Assembly shall be a Watts Series LF757DCDA, LF757NDCDA.



LF757DCDAOSY



LF757DCDABFG



LF757NDCDAOSY

### NOTICE

The information contained herein is not intended to replace the full product installation and safety information available or the experience of a trained product installer. You are required to thoroughly read all installation instructions and product safety information before beginning the installation of this product.

\*The wetted surface of this product contacted by consumable water contains less than 0.25% of lead by weight.

## Available Models

Suffix:

- OSY – UL/FM outside stem and yoke resilient seated gate valves
- BFG – UL/FM grooved gear operated butterfly valves with tamper switch
- \*\*OSY FxG – Flanged inlet gate connection and grooved outlet gate connection
- \*\*OSY GxF – Grooved inlet gate connection and flanged outlet gate connection
- \*\*OSY GxG – Grooved inlet gate connection and grooved outlet gate connection

Available with grooved NRS gate valves - consult factory\*\*

Post indicator plate and operating nut available - consult factory\*\*

\*\*Consult factory for dimensions

## Materials

Housing & Sleeve: 304 (Schedule 40) Stainless Steel

Elastomers: EPDM, Silicone and Buna-N

Tri-link Checks: Noryl®, Stainless Steel

Check Discs: Reversible Silicone or EPDM

Test Cocks: Lead Free\* Bronze Body Nickel Plated

Pins & Fasteners: 300 Series Stainless Steel

Springs: Stainless Steel

## Pressure – Temperature

Temperature Range: 33°F – 140°F (0.5°C – 60°C)

Maximum Working Pressure: 175psi (12.1 bar)

## Approvals



## Dimensions – Weight

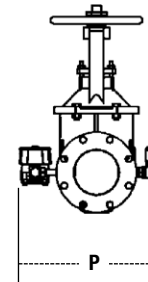
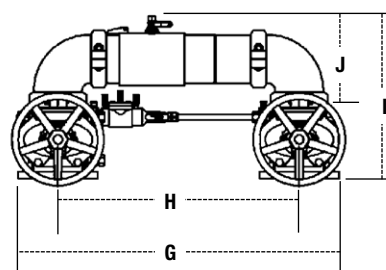
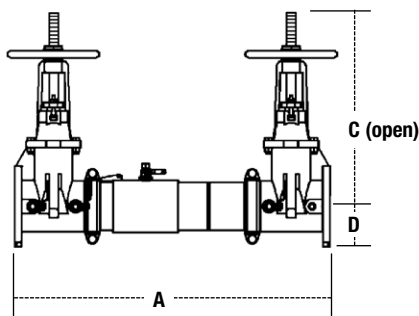

**LF757DCDA , LF757NDCDA**

SIZE		DIMENSIONS										WEIGHT									
in.	mm	A		C (OSY)		D		G		H		I		J		P		LF757DCDA		LF757NDCDA	
in.	mm	in.	mm	in.	mm	in.	mm	in.	mm	in.	mm	in.	mm	in.	mm	in.	mm	lbs.	kgs.	lbs.	kgs.
2½	76.2	30¾	781	16⅜	416	3½	89	29⅞	738	21½	546	15½	393	8⅜	223	13⅜	335	139	63	147	67
3	76.2	31¾	806	18⅞	479	3⅞	94	30¼	768	22¼	565	17⅞	435	9⅞	233	14½	368	159	72	172	78
4	101.6	33¾	857	22¼	578	4	102	33	838	23½	597	18½	470	9⅞	252	15⅞	386	175	79	198	90
6	152.4	43½	1105	30⅞	765	5½	140	44¾	1137	33¼	845	23¾	589	13⅞	332	19	483	309	140	350	159
8	203.2	49¾	1264	37¼	959	6⅞	170	54⅞	1375	40⅞	1019	27⅞	697	15⅞	399	21⅞	538	494	224	569	258
10	254.0	57¾	1467	45¾	1162	8⅞	208	66	1676	49½	1257	32½	826	17⅞	440	24	610	795	361	965	438

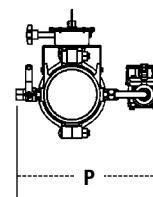
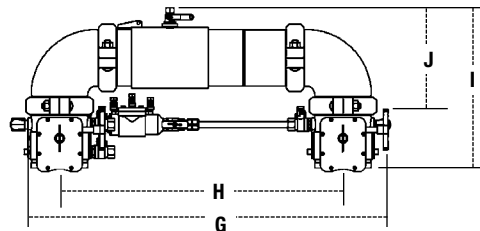
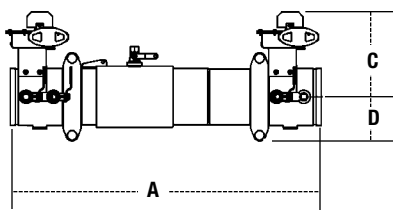

**LF757DCDABFG , LF757NDCDABFG**

SIZE		DIMENSIONS										WEIGHT									
in.	mm	A		C		D		G		H		I		J		P		LF757DCDABFG		LF757NDCDABFG	
in.	mm	in.	mm	in.	mm	in.	mm	in.	mm	in.	mm	in.	mm	in.	mm	in.	mm	lbs.	kgs.	lbs.	kgs.
2½	76.2	27¾	705	8	203	3½	89	29⅞	759	21½	546	14⅞	379	8⅜	223	13	330	70	32	78	35
3	101.6	28¼	718	8⅞	211	3⅞	94	30⅞	779	22¼	565	15⅞	392	9⅞	233	13½	343	68	31	81	37
4	127.0	29	737	8⅞	227	3⅞	94	31⅞	811	23½	597	16¼	412	9⅞	252	14	356	75	34	98	44
6	152.4	36½	927	10	254	5	127	43⅞	1097	33¼	845	19⅞	500	13⅞	332	14½	368	131	59	171	78
8	203.2	42¾	1086	12¼	311	6½	165	51⅞	1297	40⅞	1019	23¾	592	15⅞	399	18⅞	462	275	125	351	159

# Capacity

Series LF757DCDA flow curves as tested by Underwriters Laboratory. Flow characteristics collected using butterfly shutoff valves

— Horizontal — Vertical - - - - N - Pattern

## Flow capacity chart identifies valve performance based upon rated water velocity up to 25fps

- Service Flow is typically determined by a rated velocity of 7.5fps based upon schedule 40 pipe.
- Rated Flow identifies maximum continuous duty performance determined by AWWA.
- UL Flow Rate is 150% of Rated Flow and is not recommended for continuous duty.
- AWWA Manual M22 [Appendix C] recommends that the maximum water velocity in services be not more than 10fps.

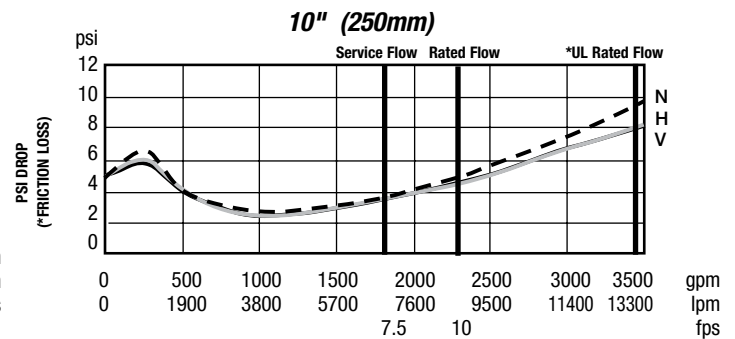
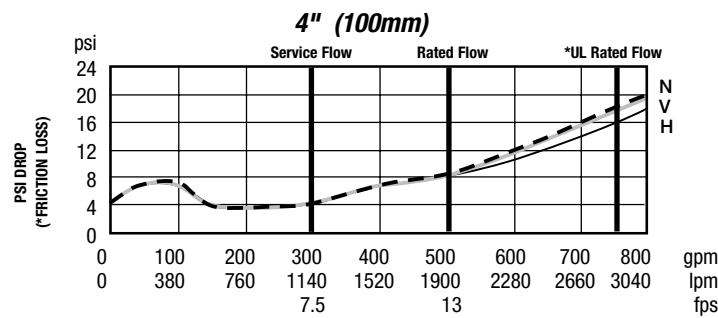
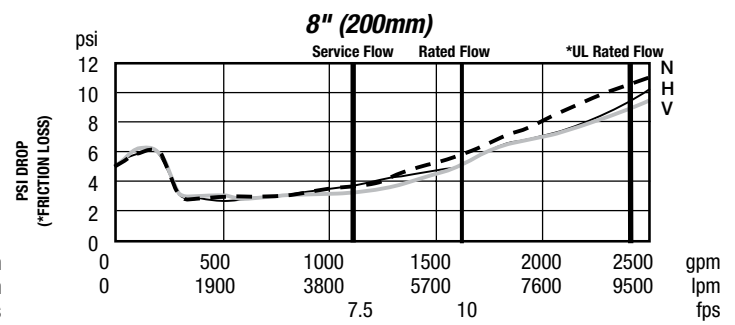
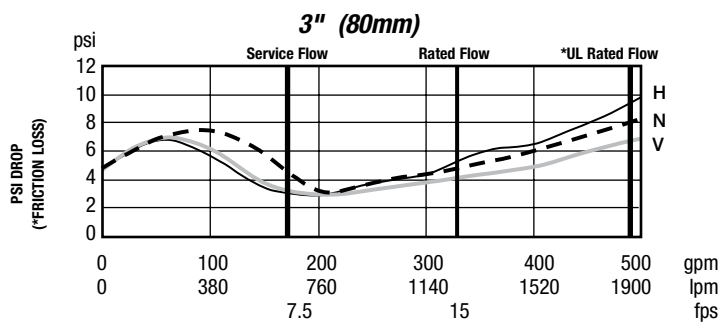
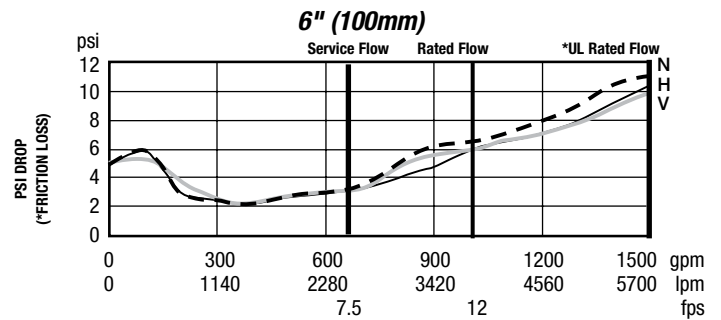
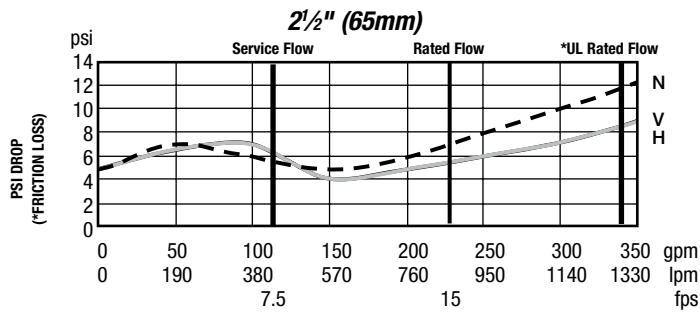

### NOTICE

Inquire with governing authorities for local installation requirements



*A Watts Water Technologies Company*

ES-LF757DCDA/LF757NDCDA 1417

**USA:** Tel: (978) 689-6066 • Fax: (978) 975-8350 • [Watts.com](http://Watts.com)  
**Canada:** Tel: (905) 332-4090 • Fax: (905) 332-7068 • [Watts.ca](http://Watts.ca)  
**Latin America:** Tel: (52) 81-1001-8600 • Fax: (52) 81-8000-7091 • [Watts.com](http://Watts.com)

© 2014 Watts